

Plan

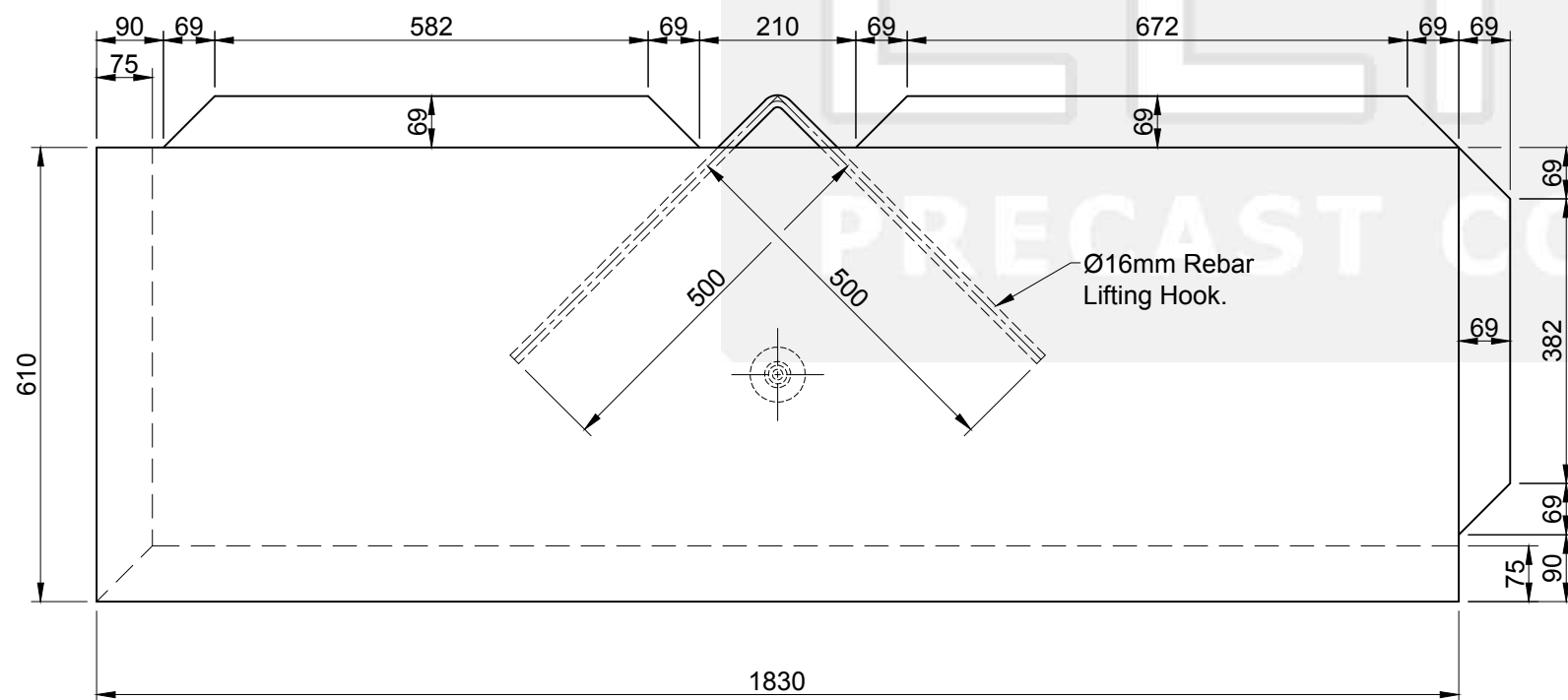

Elevation

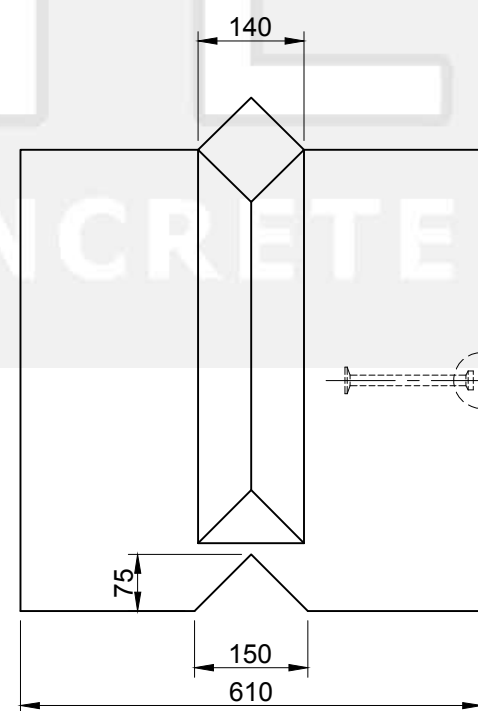

End

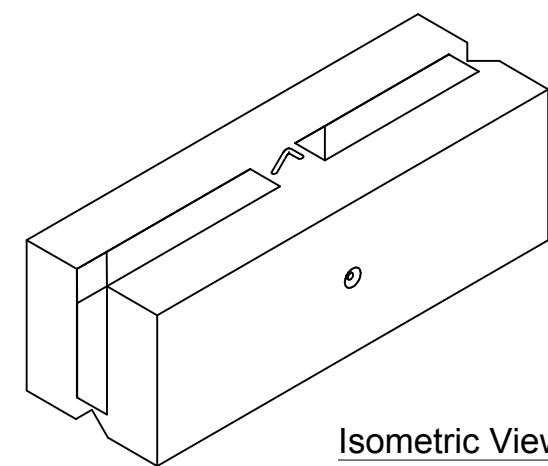

1. Handling

- Unit Volume / Weight

Unit Ref	Volume (m³)	Weight (kg)
B1-1830	0.677	1600

- Weight is based on 2350 kg/m³
- Lifting system is by means of a 16mm dia. inverted 'V' hook using lifting chains or similar certified lifting system. Hook certified to : (LOLER 1998), (PUWER) 1998 (The spherical pin anchor is used for production purposes only).

2. Concrete

- Characteristic 28 day cube strength = 50 N/mm² min.
- Concrete is Class A1 Fire Resistant in accordance with clause 4.3.4.4 of EN 13369.

3. Manufacture

- Manufactured to : BS EN 13369 : 2013
- Tolerances to : BS EN 13670 : 2009

4. Physical & Chemical Properties

- Appearance : Grey in Colour
- Other Chemical Properties : Not Applicable

5. Design

- Design Life : >100 years

6. Manufacture Tolerances

- Length ± 5mm
- Width ± 5mm
- Height ± 5mm

REV	DATE	REASON FOR ISSUE	DRN	APP	REV	DATE	REASON FOR ISSUE	DRN	APP	TITLE	SIZE	SCALE	DRG	REV
					A	03.01.18	Drawing revised & updated.	CTC	RMD	Vee™ Interlocking Concrete Block B1 - 1830 x 610 x 610 Elite Product Code : B1-1830	A3	1:10	EPC-VEE-001	A
					O	28.06.16	For Information.	CTC	RMD					
										ELITE PRECAST CONCRETE LTD HALESFIELD 9, TELFORD SHROPSHIRE TF7 4QW				
										ELITE PRECAST CONCRETE				
										DATE 28-06-16				